

# HANDLEBAR BAG WITH PHONE CHARGER KIT

P/N 2883687; 2883786



## APPLICATION

Verify accessory fitment at [Polaris.com](http://Polaris.com).

## BEFORE YOU BEGIN

Read these instructions and check to be sure all parts and tools are accounted for. Please retain these installation instructions for future reference and parts ordering information.

## KIT CONTENTS

This Kit includes:

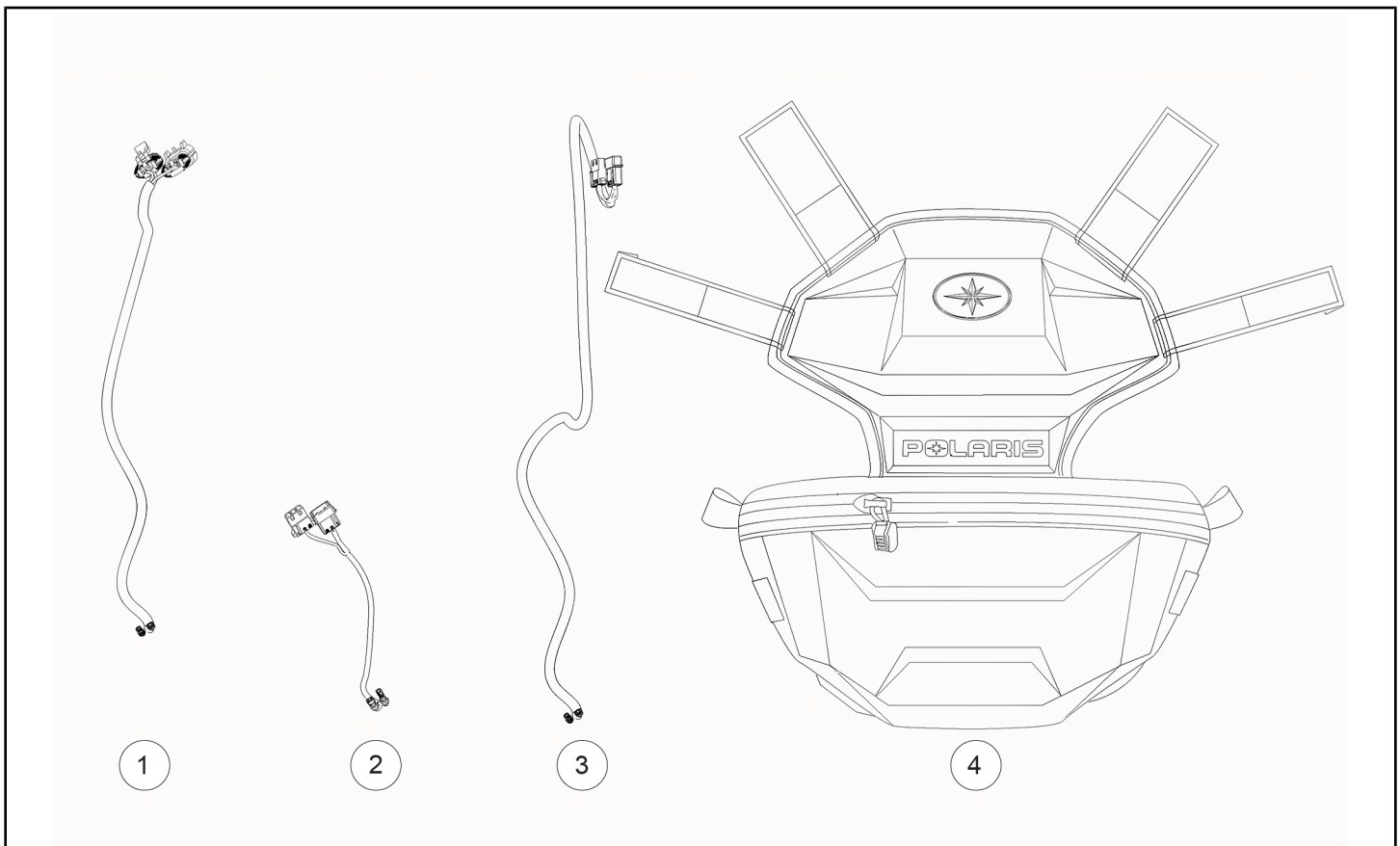

REF	QTY	PART DESCRIPTION	KIT PN 2883687	KIT PN 2883786
1	1	Harness - 850	2414585	2414585
2	1	Harness - Titan	-	2414584
3	1	Harness - 600/800	2414491	2414491
4	1	Bag - HB USB Charge	2688874 -	- 2688951
	1	Instructions	9928802	9928802

## TOOLS REQUIRED

- Safety Glasses
- Pliers, Push Pin Rivet
- Pliers, Side Cutting
- Socket Set, Metric
- Socket Set, Torx® Bit
- Torque Wrench
- Wrench Set, Metric

## IMPORTANT

Your HANDLEBAR BAG WITH PHONE CHARGER KIT is exclusively designed for your vehicle. Please read the installation instructions thoroughly before beginning. Installation is easier if the vehicle is clean and free of debris. For your safety, and to ensure a satisfactory installation, perform all installation steps correctly in the sequence shown.

## ASSEMBLY TIME

Approximately 30 minutes

### NOTE

Additional time may be required for optional steps, or to accommodate other installed accessories.

## INSTALLATION INSTRUCTIONS

### CAUTION

**BEFORE STARTING INSTALLATION**, always ensure vehicle is properly secured on a flat stable surface to avoid accidental tipping, unwanted movement and to prevent personal injury and/or damage to equipment. Turn key to "OFF" position and remove from vehicle.

### NOTE

Images shown may vary from your specific model vehicle. Installation steps are similar between models unless otherwise specified.

### 1. REMOVE SIDE PANELS.

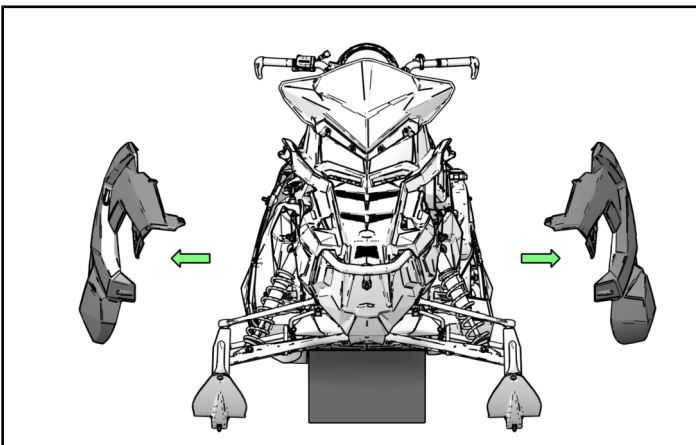

### 2. REMOVE HOOD.

- Slightly lift the rear of the hood assembly to gain access to the main hood harness connector (A) and disconnect from main chassis harness connector (B). If applicable, cut the cable tie (C) securing the hood harness to the chassis and remove hood.

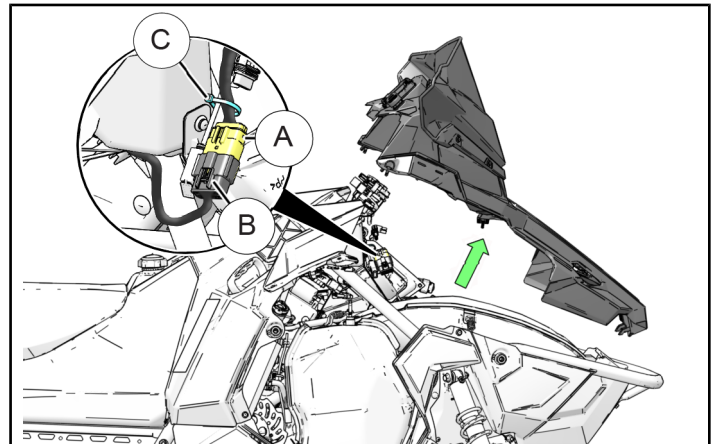

### 3. REMOVE UPPER INTAKE PLENUM.

- a. To do so, first remove the two dart clips (A) and cable tie (B) that fasten the intermediate intake tube (C) to the upper intake plenum..

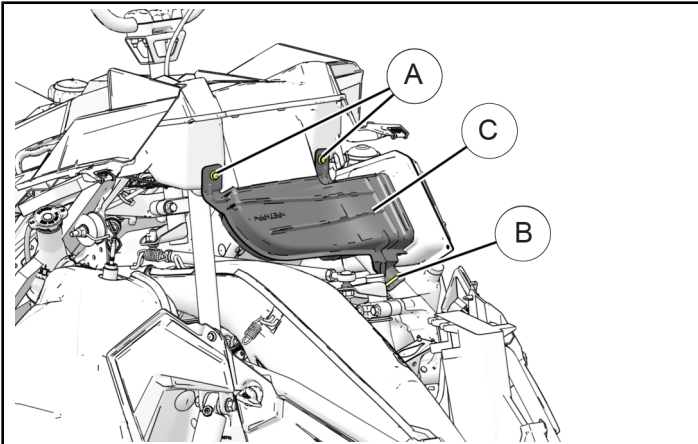

- b. Next, unplug the two electrical connectors (D) from the ECU (E).

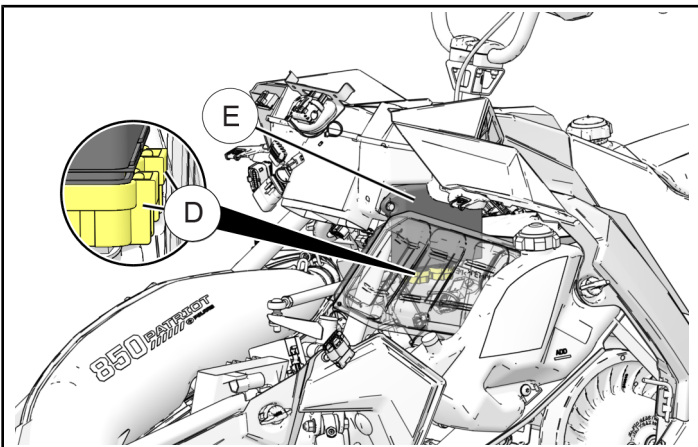

- c. Remove the two screws (F) that attach the upper intake plenum (H) to the over-structure along with the two dart clips (G) as shown. Once complete, remove upper intake plenum (H).

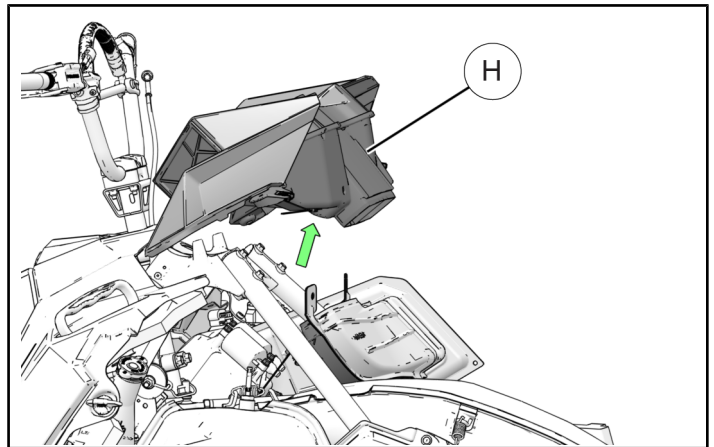
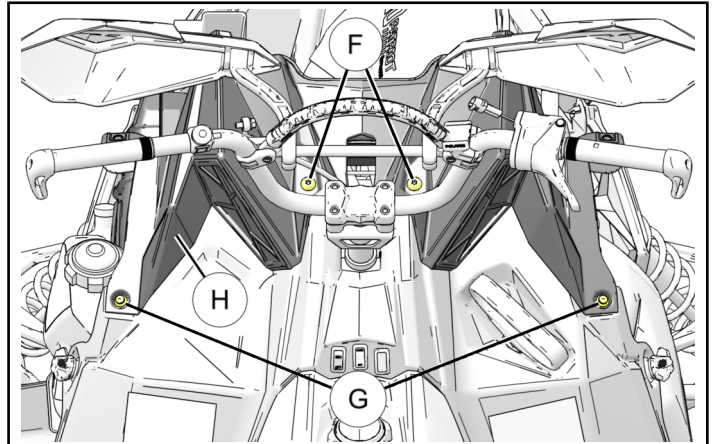

#### 4. REMOVE CONSOLE.

- a. Remove two dart clips **A** on right side along with clutch tool **B** and dart clip **C** from left side and slide the console rearward leaving the starter rope attached.

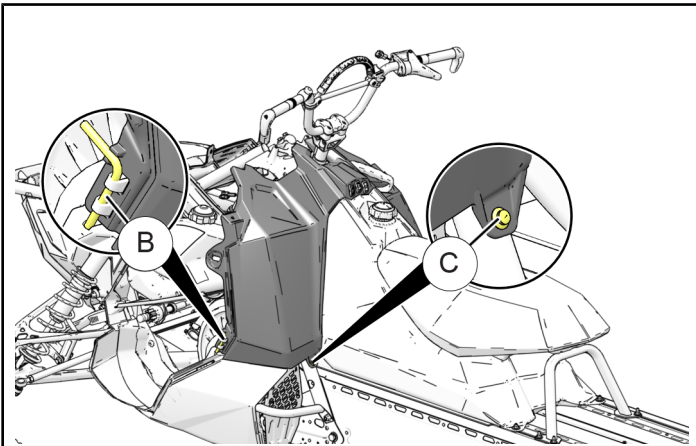
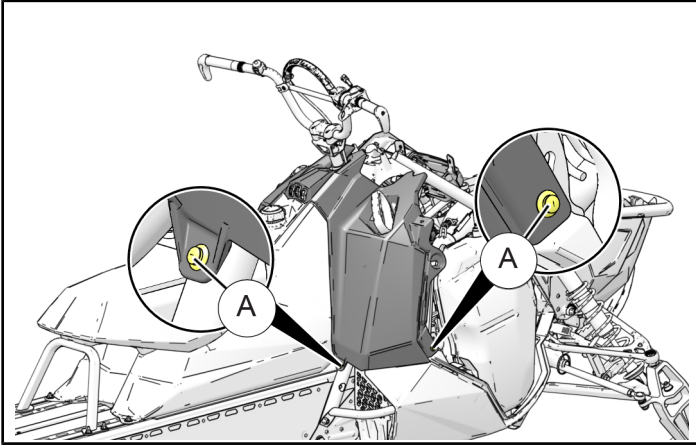

The console should now be in a position to allow you to access the fabric electrical connections bag in the following steps.

#### 5. SELECT HARNESS.

- a. For **850 models** use harness ①. See detailed image.
  - Connector (1a) will get connected to the chassis harness.
  - Connector (1b) is a spare connector for use with additional accessories.
  - Connectors (1c) connect to the USB terminals on the bag.

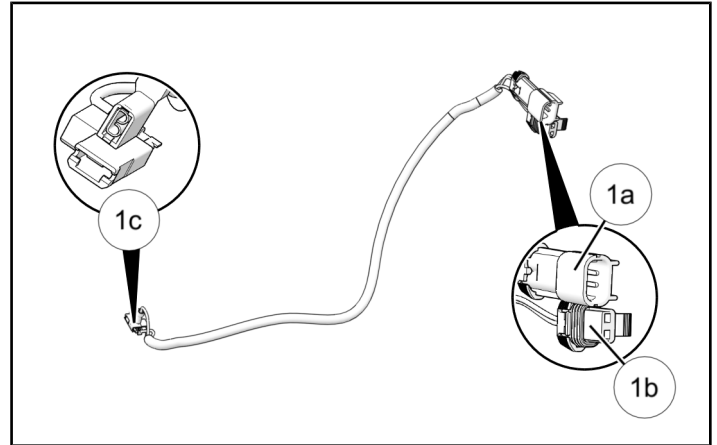

- b. For **Titan™ models** use harness ②. See detailed image.

- Connector (2a) will get connected to the chassis harness.
- Connector (2b) is a spare connector for use with additional accessories.
- Connectors (2c) connect to the USB terminals on the bag.

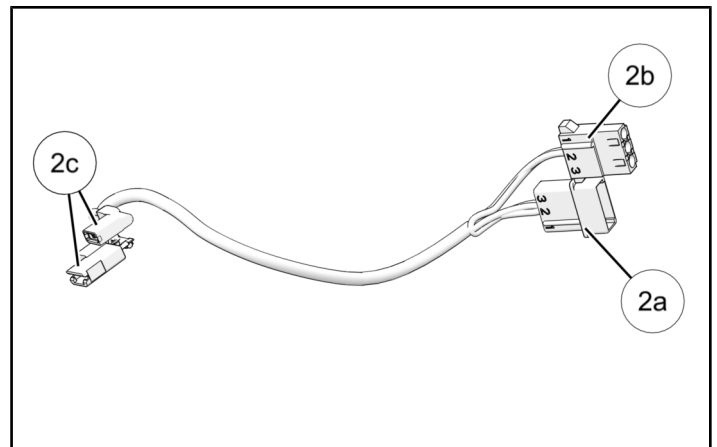

c. For **600/800 models** use harness ③.

- Connector (3a) will get connected to the chassis harness.
- Connector (3b) is a spare connector for use with additional accessories.
- Connectors (3c) connect to the USB terminals on the bag.

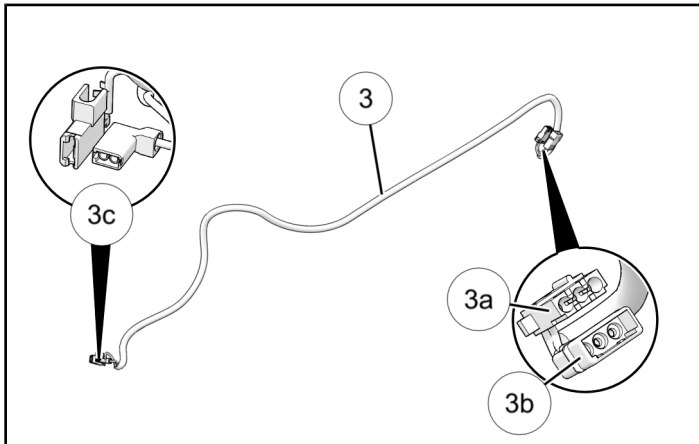

b. Place bag over top of handlebars being sure wires are routed downward along the handlebar post.

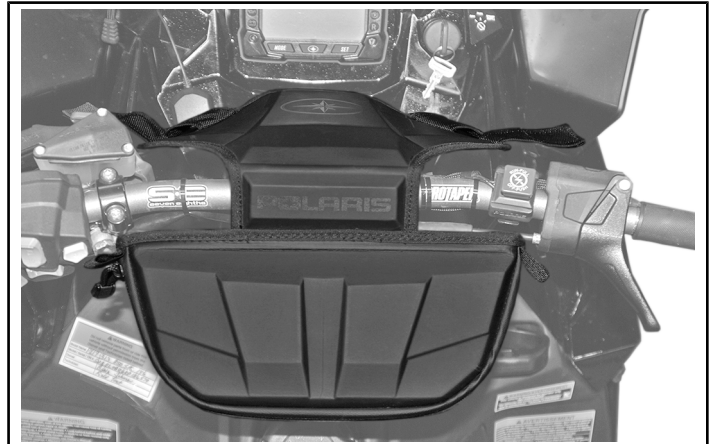

c. Secure bag onto handlebars with the two hook and loop fastener panels on each side of bag.

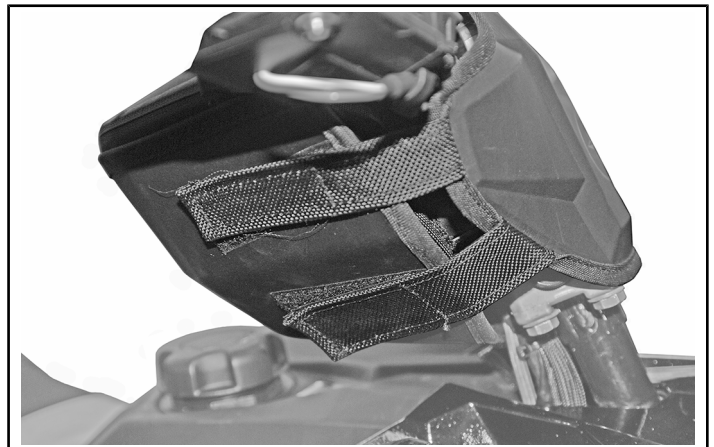

## 6. MOUNT HANDLEBAR BAG.

a. Ensure the USB harness connections are connected to USB terminals on the back of the bag. Place bag into position as shown.

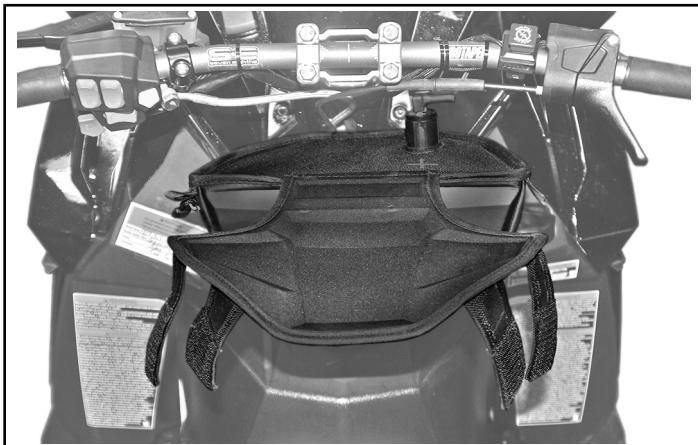

## 7. ROUTE AND CONNECT HARNESS WIRES.

### NOTE

Electrical connections and routing vary slightly between models. Follow steps for you specific model for proper installation.

#### a. 850 Models

- i. Route USB harness wires down along steering post to the electrical connections bag **B** located under the console.

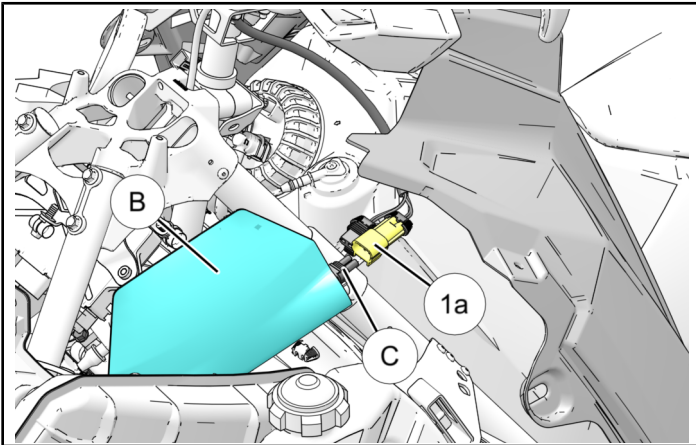

Open bag and connect USB harness connection (1A) to chassis harness connector **C** as shown.

#### b. Titan Model

- i. Route USB harness wires down along steering post to the electrical connections bag **B** located under the console. Open bag and connect USB harness connection (2A) to chassis harness connector **C** as shown.

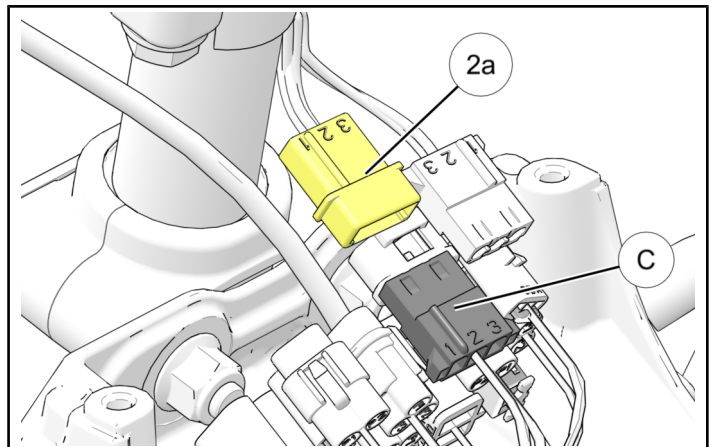
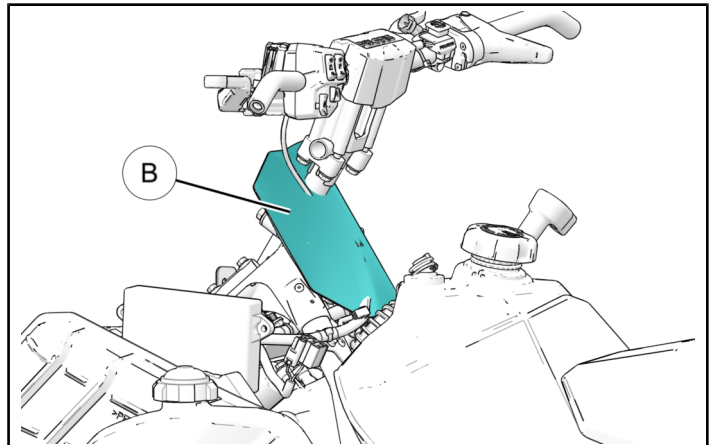

#### c. 600/800 Models

- i. Route USB harness wires down along steering post then along the left hand over-structure tube to connector **C** located near the left hand shock tower. Connect USB harness connection (3A) to chassis harness connector **C** as shown.

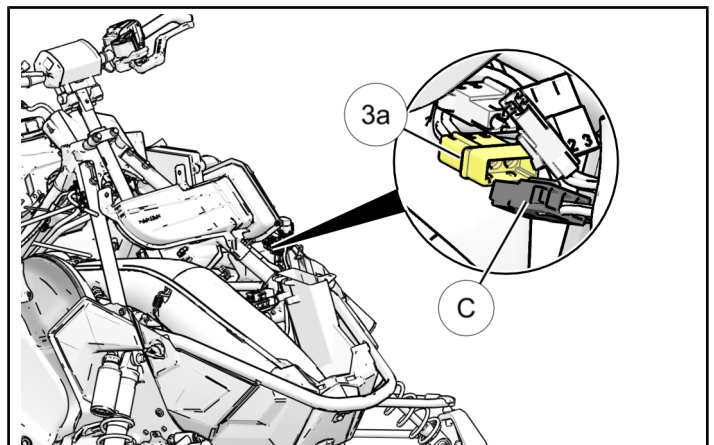

## 8. REINSTALL CONSOLE.

- a. Place console into original position and install previously removed dart clips **(A)** on right side along with the clutch tool **(B)** and dart clip **(C)** on left side.

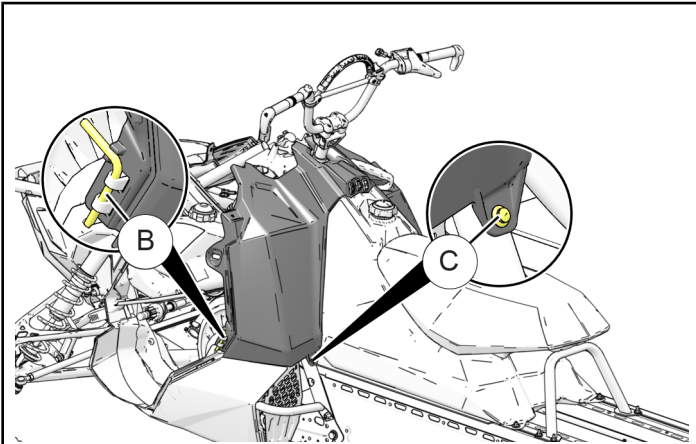
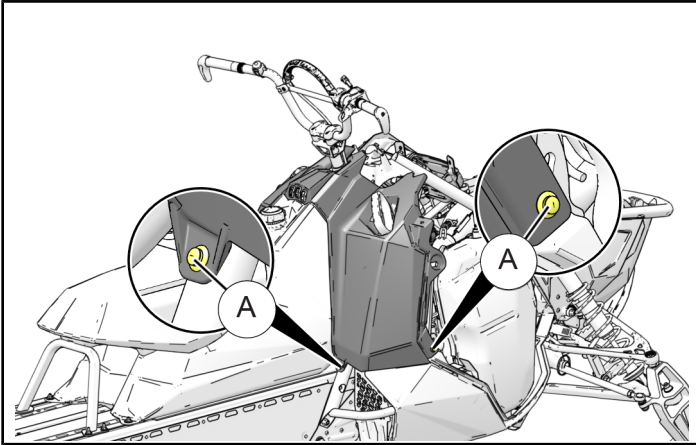

## 9. REINSTALL UPPER INTAKE PLENUM.

- a. Carefully install upper intake plenum **(A)** back into original position. Ensure the console tabs **(B)** are fully engaged into the slots **(C)** on the underside of the intake plenum.

### NOTE

Be careful not to damage the intake screen while installing upper intake plenum.

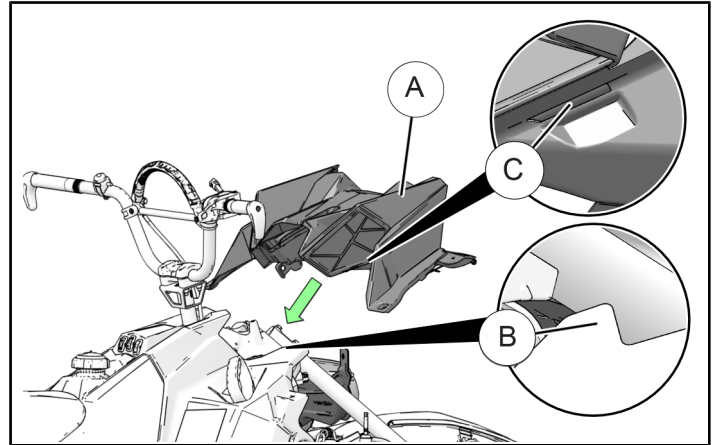

- b. Install dart clips **(D)** and fasteners **(E)** that secure the intake plenum **(A)** to the over-structure and torque fasteners **(E)** to specification provided

### TORQUE

7 ft. lbs. (10 Nm)

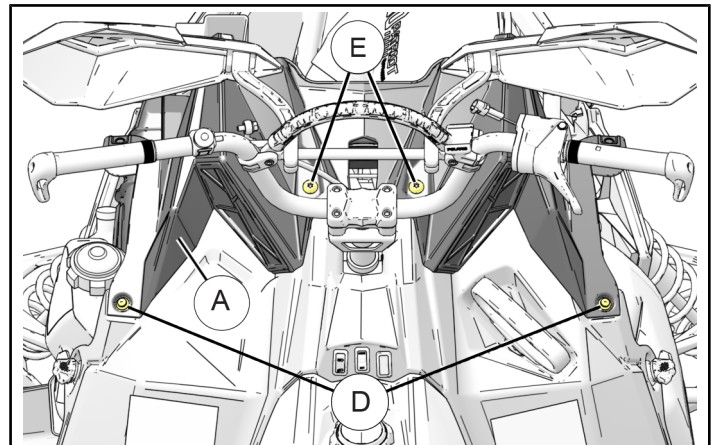

- c. Place intake tube (F) back into position and secure with previously removed dart clip fasteners (G). Replace cable tie (H) to secure lower portion of intake tube.

**IMPORTANT**

Ensure the mating joint between the upper intake plenum and the intake tube is completely engaged all the way around the mating joint. Failure to do so may result in premature engine failure.

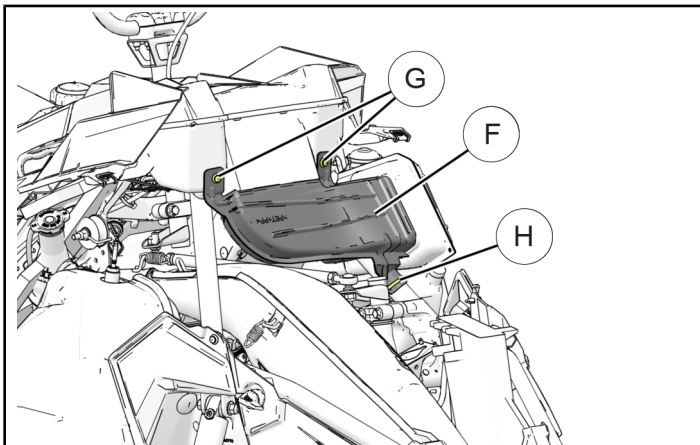

- d. Reconnect ECU by plugging the chassis electrical harness connector (J) in the ECU (K).

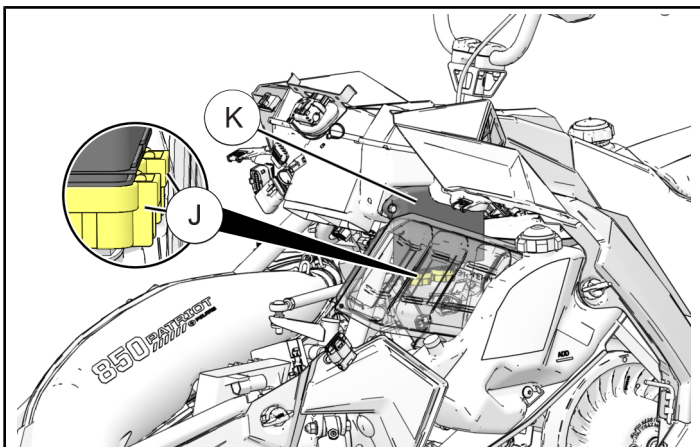

**10. REINSTALL HOOD.**

- a. Install hood being sure to connect the hood harness (A) and chassis harness (B) connection. Replace cable tie (C) if applicable. Secure hood into position with hood latch fasteners.

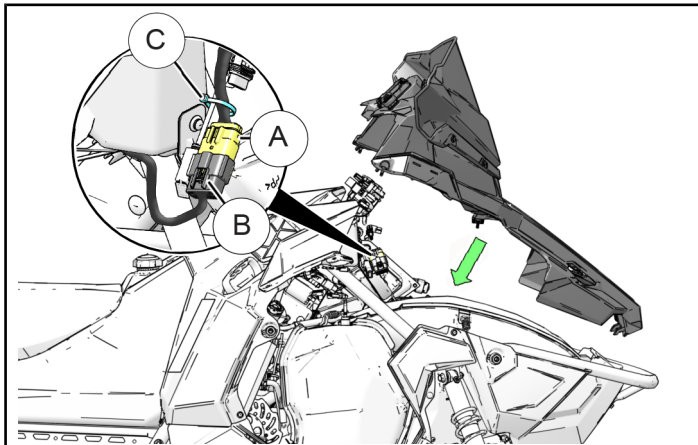

**11. REINSTALL SIDE PANELS.**

- a. After installing hood, install both side panels making sure all hood latches and rubber straps are fully secured.

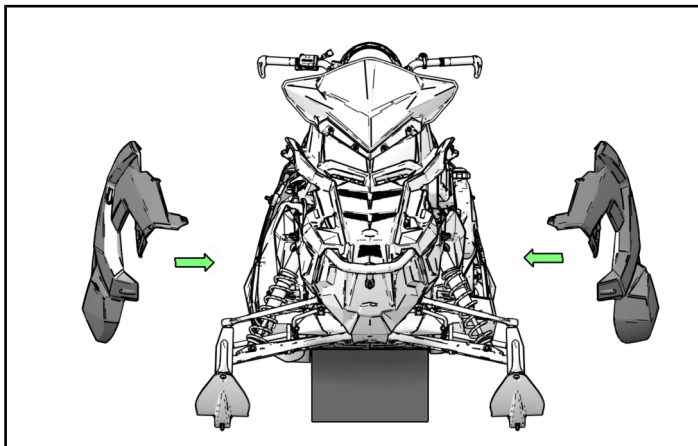

**12. VERIFY WORK.**

- a. Check to ensure all tools are accounted for and all steps have been completed.

**FEEDBACK FORM**

A feedback form has been created for the installer to provide any comments, questions or concerns about the installation instructions. The form is viewable on mobile devices by scanning the QR code or by clicking [HERE](#) if viewing on a PC.

**FEEDBACK FORM**

